

ProBike

The motorcycle clamping device

Series 815



Operating instructions
Product overview
Motorbike data



GEB 001 155

Table of Contents

1.	Product overview ProBike Series 815	2
1.1	ProBike for conical mechanical connection	2
1.2	ProBike for cylindrical mechanical connection	3
1.3	ProBike Upgrade kit.....	4
2.	The <i>QuickFix</i> rapid clamping unit	6
3.	Assembling the clamping device on the wheel balancing machine	7
3.1	Assembly on a wheel balancing machine with a cylindrical shaft connection	7
3.2	Assembly on a wheel balancing machine with a conical shaft connection	9
3.3	Mounting differences with a conical shaft connection	11
4.	Instructions for using special centering kits	13
5.	Variants for wheel centering.....	18
6.	ProBike spare parts and accessories	19
6.1	Spare parts	19
6.2.	Accessories	19
7.	Overview of the Motorbike Data.....	20
7.1	Motorbike Data Tables	20

Last updated: October 2019

Subject to technical modifications.

Version 4.0

Figures: HAWEKA AG / D-30938 Burgwedel

Reproduction in any form is not permitted.

1. Product overview ProBike Series 815

The ProBike motorcycle clamping device forms the basic equipment needed to balance motorcycle wheels with a wheel balancer. Depending on which type of wheel balancing machine on which the ProBike wing is attached, either a cylindrical or a conical insert chuck must be used for the shaft connection.

1.1 ProBike for conical mechanical connection

Article No. 815 818 010

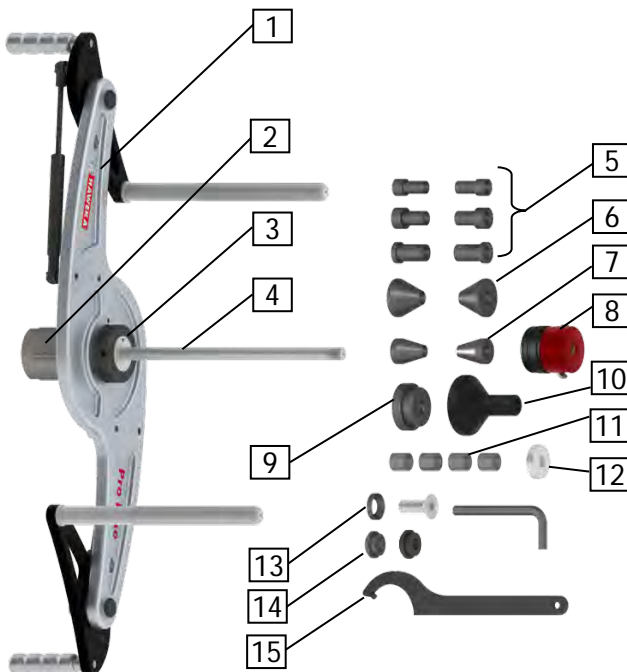

Figure:
ProBike with conical connection

No.	Item name	Quantity	Article No.
1	ProBike carrier wing	1	803e008 030
2	Conical insert chuck	1	803e999 003
3	Round pin nut M45 x 1	1	803e008 036
4	Motorbike shaft Ø 14 mm	1	870e012 140
5	Motorbike centering sleeves 15 mm	2	860e140 150
5	Motorbike centering sleeves 17 mm	2	860e140 170
5	Motorbike centering sleeves 20 mm	2	860e140 200
6	Centering cone 16 - 45 mm	2	850e140 006
7	Standard centering cone	2	850e140 001
8	QuickFix for Ø 14 mm shaft	1	890 140 001
9	Centering sleeve Piaggio/Vespa	1	860e140 460
10	Polyamide pressure piece for BMW	1	860e140 006
11	Spacing sleeves 15 mm	4	860e150 002
12	Knurled nut M14 x 1.25	1	840e140 001
13	Mounting bush insert chuck with countersunk bolt DIN7991-M16x40	1	803e008 034
		1	D07991 16040
14	Adapter Pneumatic M114 x 1,5	1	803e008 045
	Adapter Pneumatic M14	1	803e008 054
15	Pin Wrench	1	D01810 B58062

1.2 ProBike for cylindrical mechanical connection

Article No. 815 XX1 010



XX1 = Shaft diameter of the wheel balancing machine (∅ 28 mm -> XX = 28)
 (∅ 36 mm -> XX = 36)
 (∅ 38 mm -> XX = 38)
 (∅ 40 mm -> XX = 40)

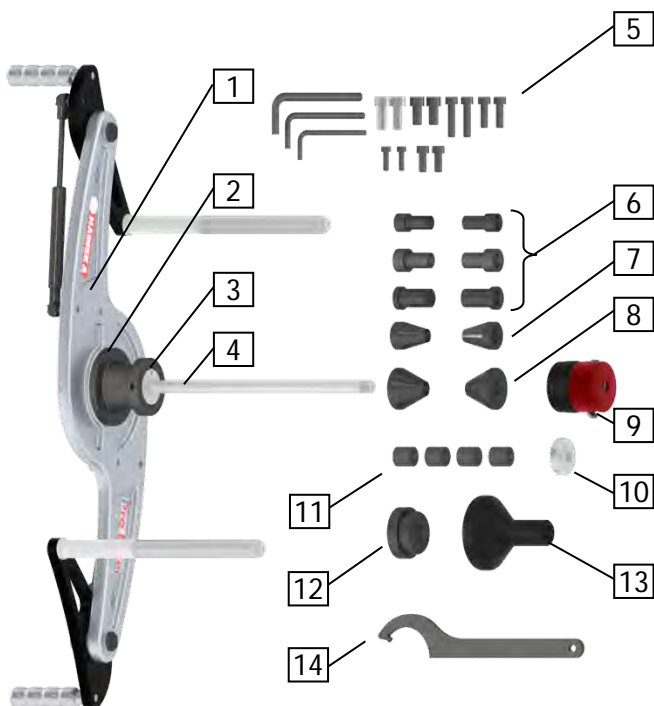

No.	Item name	Quantity	Article No.
1	ProBike carrier wing	1	803e008 030
2	Cylindrical insert chuck*	1	803e008 0XX*
3	Round pin nut M45 x 1	1	803e008 036
4	Motorbike shaft 14 mm	1	870e012 140
5	Fixing kit	1	405 008 003
6	Motorbike centering sleeves 15 mm	2	860e140 150
6	Motorbike centering sleeves 17 mm	2	860e140 170
6	Motorbike centering sleeves 20 mm	2	860e140 200
7	Standard centering cone	2	850e140 001
8	Centering cone 16 - 45 mm	2	850e140 006
9	QuickFix for ∅ 14 mm shaft	1	890 140 001
10	Knurled nut M14 x 1.25	1	840e140 001
11	Spacing sleeve 15 mm	4	860e150 002
12	Centering sleeve Piaggio/Vespa	1	860e140 460
13	Polyamide pressure piece for BMW	1	860e140 006
14	Pin Wrench	1	D01810 B58062

Figure:
ProBike with cylindrical connection

* Position 2 varies dependent on the machine model
Article No!

	Cylindrical insert chuck ∅ 40 mm	803e008 033
	Cylindrical insert chuck ∅ 38 mm	803e008 043
	Cylindrical insert chuck ∅ 36 mm	803e008 042
	Cylindrical insert chuck ∅ 28 mm	803e008 041

The wall board included in the scope of delivery is intended for safe storage of the individual parts as well as storing the carrier wing.

Wall board Article No. 900 008 142

Refer to the separate assembly instructions MAL 900 003 for assembling the wall board.



You can upgrade the ProBike motorcycle clamping device individually at any time.

1.3 ProBike Upgrade kit

Article No. 815 008 002

Specially approved for heavy motorbike wheels with quick-release axle bearing.

This upgrade kit contains a strengthened motorbike shaft with a 19 mm diameter and the appropriate centering sleeve for various centering ranges up to Ø 35 mm (wheel bearing). A QuickFix for the Ø 19 mm motorbike shaft, spacing sleeves and knurled nut as well as an additional wall board.

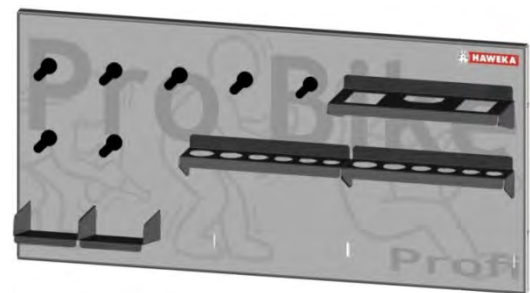

Wall board Article No. 900 008 143

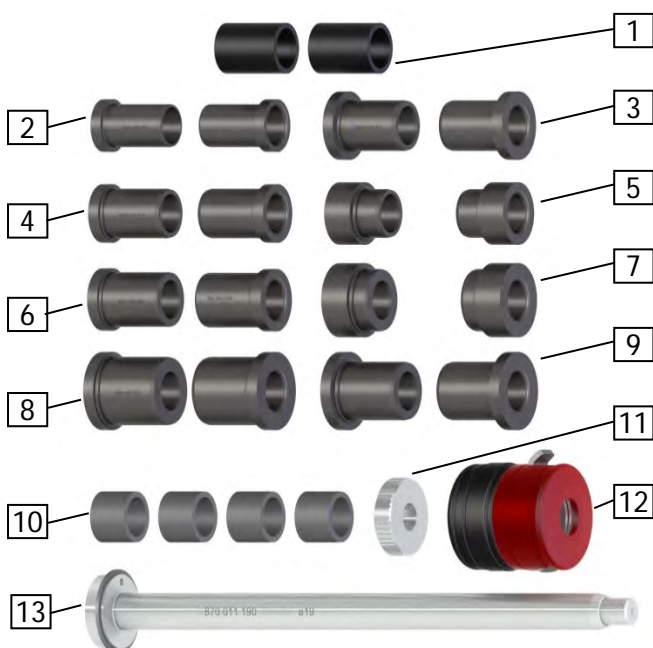

No.	Item name	Quantity	Article No.
1	Pressure piece Harley Davidson	2	860e190 260
2	Centering sleeve Ø 22 mm	2	860e190 220
3	Centering sleeve Ø 26 mm	2	860e190 261
4	Centering sleeve Ø 25.4 mm	2	860e190 254
5	Centering sleeve Ø 25 mm Suzuki	2	860e190 250
6	Centering sleeve Ø 28 mm	2	860e190 280
7	Centering sleeve Ø 32 mm Suzuki	2	860e190 320
8	Centering sleeve Ø 35 mm	2	860e190 350
9	Centering sleeve Ø 30 mm	2	860e190 300
10	Spacing sleeve (Internal Ø 20 mm)	4	860e200 002
11	Knurled nut M14 x 1.25	1	840e140 001
12	QuickFix for Ø 19 mm shaft	1	890 190 001
13	Motorbike shaft Ø 19 mm	1	870e012 190

The Profi-Kit for Mono-arm models has a much more individualised handling behaviour and provides you with possibility to also balance motorbike wheels from vehicles with Mono-arm.

Article No. 815 008 003

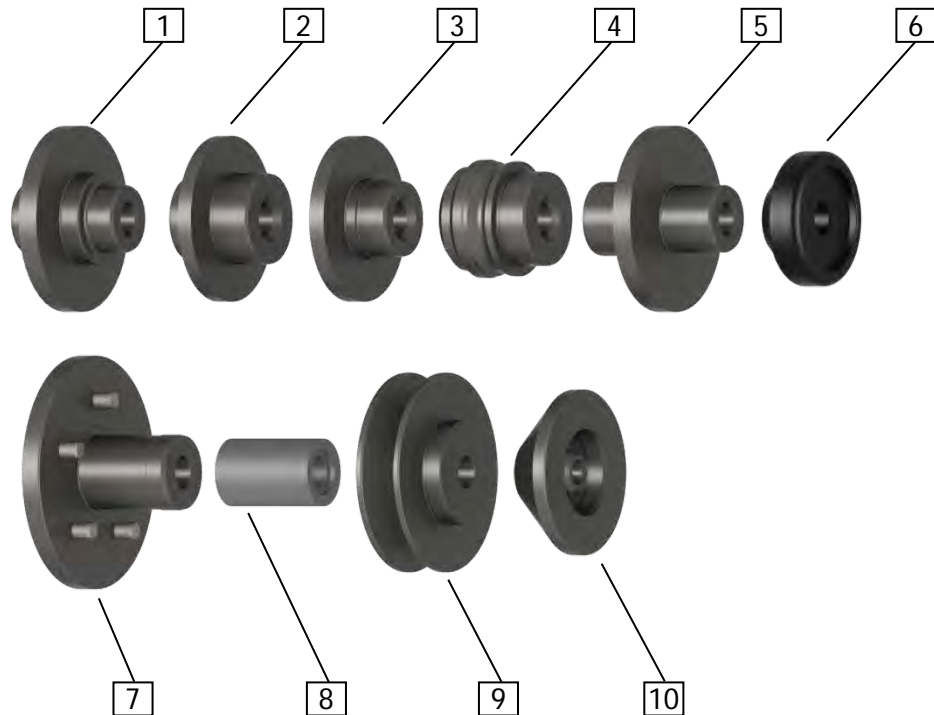

No.	Item name	Quantity	Article No.
1	Centering sleeve DUCATI	1	860e190 004
2	Centering sleeve MV AGUSTA/HONDA	1	860e190 011
3	Centering sleeve HONDA GL 1800 / NTV 650	1	860e190 018
4	Centering sleeve APRILIA/BMW / YAMAHA	1	860e190 012
5	Centering sleeve TRIUMPH/ HONDA VFR1200	1	860e190 024
6	Pressure piece	1	850e190 007
7	Centering flange KTM Superduke + TRIUMPH	1	860e190 022
8	Spacing sleeve, long	1	860e190 007
9	Centering disc BMW II (from year of manufacture 2005) also R 1200 GS	1	860e190 020
10	Centering disc BMW I (from year of manufacture 2005) apart from R 1200 GS, Moto Guzzi (from 2008) (Internal Ø 14 mm)	1	860e140 015

2. The *QuickFix* rapid clamping unit

The *QuickFix* rapid clamping unit can be utilised for all ProBike motorcycle clamping devices.

Utilising the *QuickFix* rapid clamping unit makes clamping motorbike wheels child´s play.

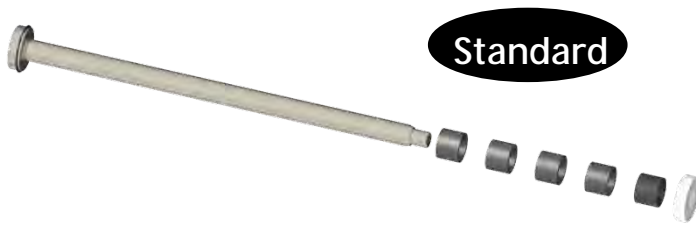

Tightening with the knurled nut can be omitted.



The *QuickFix* is pushed onto the shaft and the wheel is thereby pressed against the spacing sleeve. To create correct centering, it is necessary to subsequently tighten the black plastic ring of the *QuickFix* against the centering unit in a clockwise direction.



Note

A safe fixing is only guaranteed when the counter pressure is achieved for the black plastic ring against the wheel.

Once the application has been completed, simply loosen the black plastic ring from the *QuickFix* (rotate it anti-clockwise), actuate the toggle lever and remove the *QuickFix* from the shaft again.

For motorbike shafts Ø 14 mm Article No.: 890 140 001
 For motorbike shafts Ø 19 mm Article No.: 890 190 001



3. Assembling the clamping device on the wheel balancing machine

3.1 Assembly on a wheel balancing machine with a cylindrical shaft connection

Dismantle the middle shaft from the main body



Actuate the foot brake (when present) and, depending on which machine model, loosen the middle shaft from the main body with a suitable tool (socket wrench or screwdriver).



Assembling the ProBike carrier wing on the main body



Attach the ProBike carrier wing onto the main body and insert the fixing bolts from the rear. Then tighten the bolts evenly with the hexagonal spanner.



Always ensure that the carrier wing is secured flush on the main body.

Note

Assembling the shaft on the ProBike carrier wing



Insert the mounting shaft in the insert chuck of the carrier wing.

Firstly tighten the Round pin nut manually and then lightly tighten the Round pin nut with the supplied Pin Wrench.



Always ensure that the mounting shaft is not inserted at an angle into the chuck.

Note

Mounting the wheel on the ProBike carrier wing



There are various methods for fixing the wheel depending on the motorbike model. Always utilise the suitable centering sleeves or centering discs to clamp the wheel correctly! A wheel fixing with a quick-release axle is shown in the example.

Note



Insert the respective centering sleeves from both sides into the middle hole of the wheel.



The direction of assembly for the wheel must be selected in such a way that the largest dimension of the wheel (in this case the side with the brake disc) is pointing towards the carrier wing.



Depending on the characteristic of the rim, a various quantity of spacing sleeves are required for fixing.



The QuickFix will be pushed onto the shaft and pressed tightly against the wheel. The complete centering unit will subsequently be secured by rotating the black plastic ring on the QuickFix.



Finally the carrier from the wing will be folded onto the wheel.

Control: If the wheel is assembled tightly, then it may not rest laterally on the carrier wing!





In order to achieve the best possible results, the wheel will be assembled as close as possible to the side of the machine. Always ensure that the flank of the wheel does not come in contact with the carrier wing and is only inserted onto the shaft via the centring device.

3.2 Assembly on a wheel balancing machine with a conical shaft connection



Loosen the hexagonal socket bolt in the middle shaft



Remove the main body from the machine connection.



Attach the ProBike carrier wing onto the conical shaft end and tighten it with the hexagonal socket bolt including the disc (bevel washer) on the machine connection.



Insert the mounting shaft in the insert chuck of the carrier wing.



Firstly tighten the Round pin nut manually and then lightly tighten the Round pin nut with the supplied Pin Wrench.





There are various methods for fixing the wheel depending on the motorbike model. Always utilise the suitable centering sleeves or centering discs to clamp the wheel correctly!
This example shows how a wheel is secured with a Mono-arm.



The centering disc required for this wheel is then pushed onto the shaft.

The vehicle degree is then subsequently applied and the wheel hub is clamped on the centering disc.



Position the pressure piece on the outer side of the rim.

Depending on the characteristic of the rim, a various quantity of spacing sleeves are required for fixing.



The centering unit will be clamped tightly with the knurle nut.

Control: If the wheel is assembled tightly, then it may not rest on the carrier wing! If this is the case, then spacing sleeves must be inserted between the wing and the centering disc.



3.3 Mounting differences with a conical shaft connection (ProBike 815 818 010)

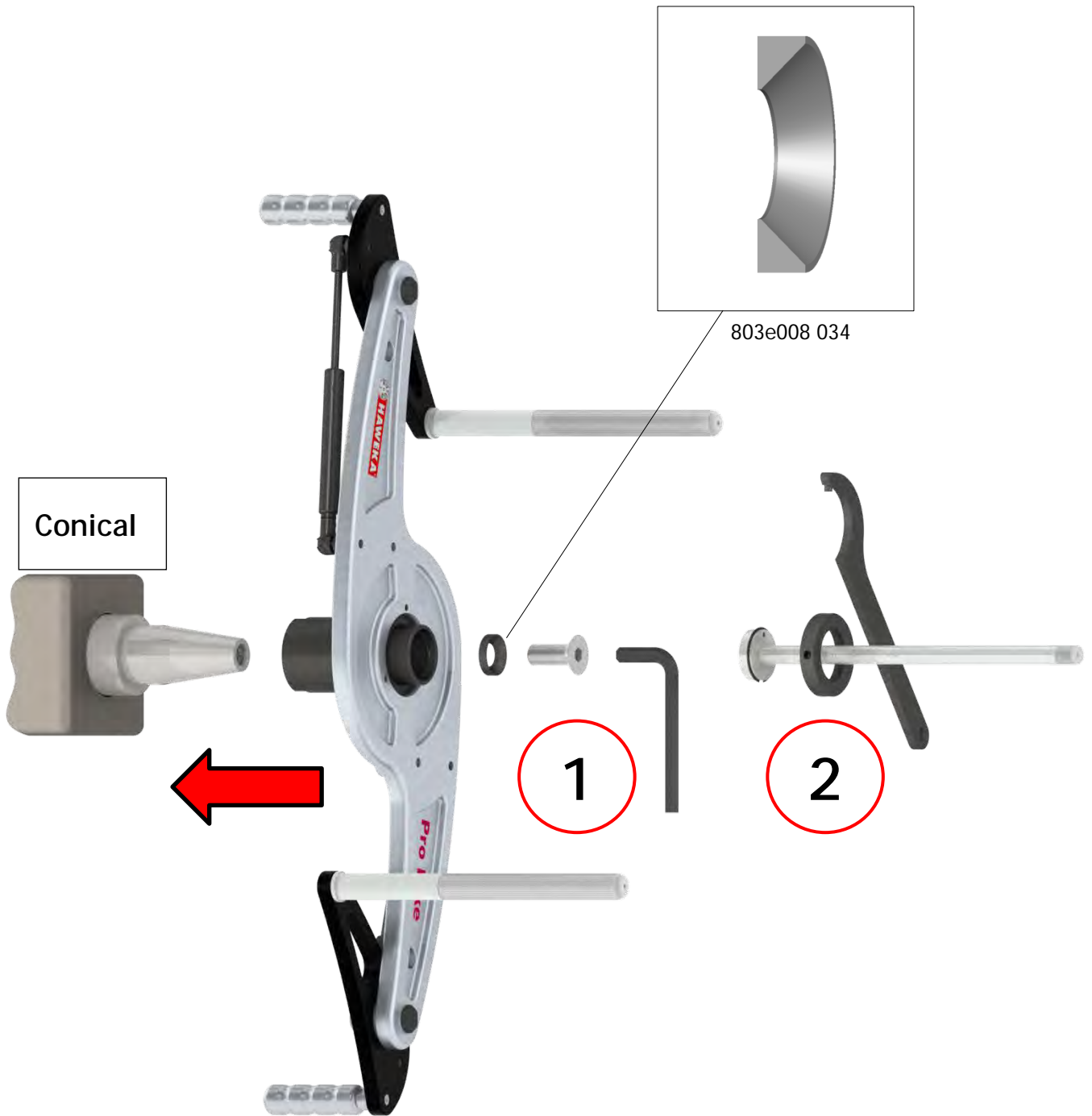

Mounting bush insert chuck with countersunk bolt DIN7991-M16x40

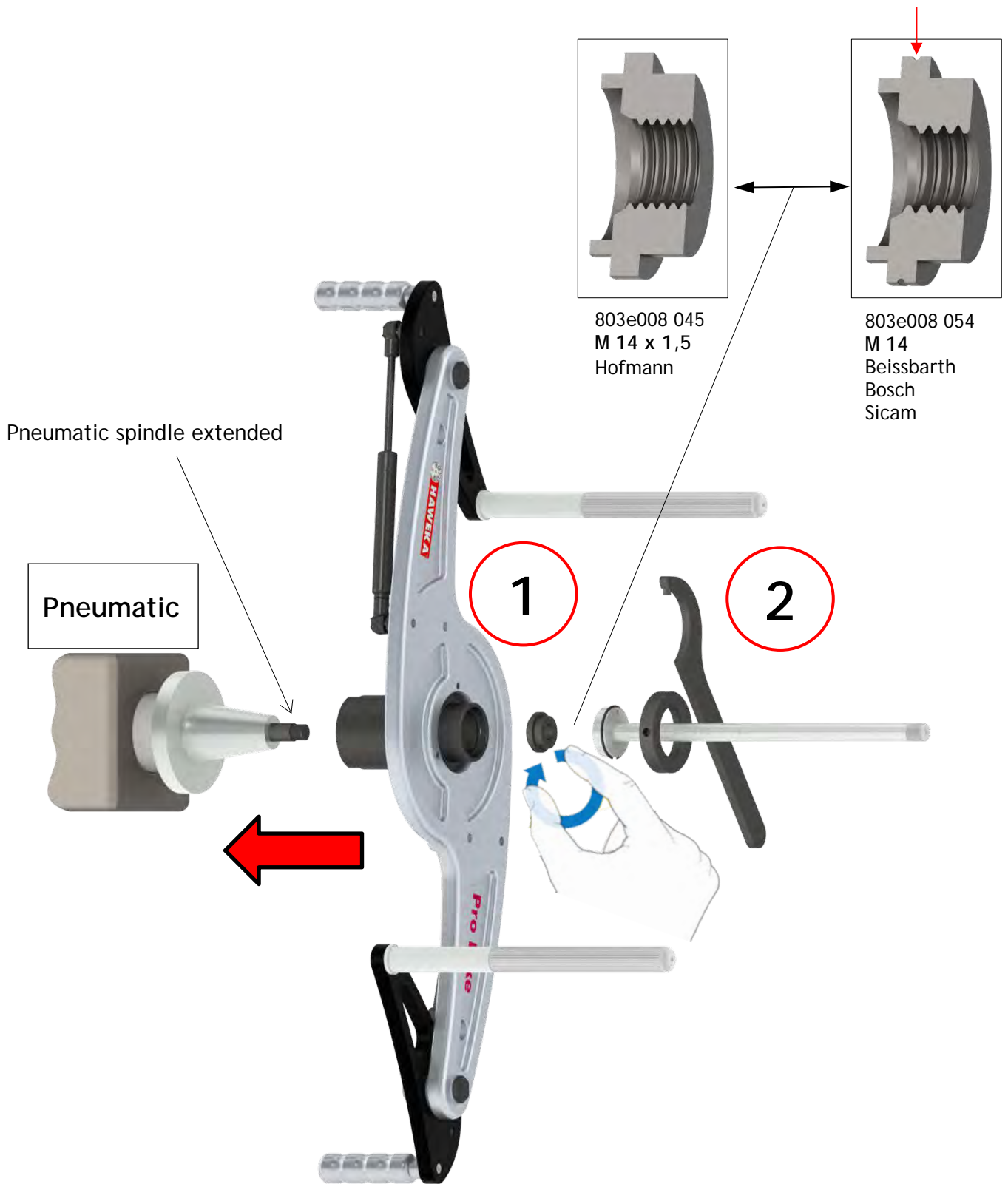

With ProBike pneumatic Adapter

4. Instructions for using special centering kits



You already have a ProBike clamping device and would like to balance motorbike wheels with a Mono-arm. If this is the case, then you will need the ProBike Upgrade Kit 815 008 003 (Page 5).

The special centering kit has been re-modified and optimised so that it is now suitable for a wider range of various motorbike wheels.

The special clamping devices from the Upgrade Kits 815 008 002 and 815 008 003 will be assembled on a \varnothing 19 mm motorbike shaft, except for one exception (860e140 015).

If you need just one specific special centering kit, then of course you can also buy them individually.



Note

If you are using individual kits, you will also need the \varnothing 19 mm motorcycle shaft and, as an option, a 19 mm QuickFix!

Differences in the shaft lengths:

Article No. 870e012 190 = Standard length, 300 mm

Article No. 870e012 191 = Extra-long, 365 mm

\varnothing 19 mm QuickFix Clamping System Article No. 890 190 001



\varnothing 19 mm shaft (870e012 190) and QuickFix are supplied with the Upgrade Kit 815 008 002!

The following pages contain some application examples for assembling the various clamping elements.

APRILIA

RST Futura (2001 - 2003)

BMW

F 650 CS Scarver (2002 - 2003)

YAMAHA

GTS 1000 (1993 - 1999)

For rear wheel mounting
(can be utilised from both sides!)

1 x Centering Sleeve Article No. 860e190 012

1 x Pressure Piece Article No. 850e190 007

(Supplied with Upgrade Kit 815 008 003)



HONDA

GL 1800 Gold Wing
NTV 650 Revere

For rear wheel mounting
(can be utilised from both sides!)

1 x Centering Sleeve Article No. 860e190 018

1 x Pressure Piece Article No. 850e190 007

(Supplied with Upgrade Kit 815 008 003)



BMW

BMW motorbikes with Mono-arm up to
year of manufacture 2005
(apart from R 1200 GS)

MOTO GUZZI

Moto Guzzi from year of manufacture
2008 with new drive unit

For rear wheel mounting

1 x Centering Disc Article No. 860e140 015

(Supplied with Upgrade Kit 815 008 003)

1 x Pressure Piece Article No. 860e140 006

(Supplied with ProBike 815 xxx 010)



Shaft Ø 14 mm



BMW

BMW motorbikes with Mono-arm from
year of manufacture 2005
BMW R 1200 GS (2004 -)

For rear wheel mounting
(can be utilised from both sides!)

1 x Centering Disc Article No. 860e190 020

1 x Pressure Piece Article No. 850e190 007

(Supplied with Upgrade Kit 815 008 003)



DUCATI

748 (up to 2003)
 848 (from 2008)
 916 (1995 - 2003)
 996 (1998 - 2001)
 998 (2002 - 2003)
 1098 (2007 - 2009)
 1198 (2009 - 2011)
 1199 Panigale (2012-)
 Diavel (2011 -)
 Hypermotard 1100 / S (2007 -)
 Hypermotard 796 (from 2010 -)
 Monster 1100 / S / EVO (2009 -)
 Monster 796
 Monster S2R / S4R (from 2007 -)
 Multistrada (2007 - 2009)
 Multistrada 1200 (2011 -)
 Streetfighter / S (2010 -)
 Streetfighter 848 (2012 -)



For rear wheel mounting (can be utilised from both sides!)

1 x Centering Sleeve Article No. 860e190 004

1 x Pressure Piece Article No. 850e190 007

(Supplied with Upgrade Kit 815 008 003)

HONDA

VFR 1200 (no Crosstourer)

TRIUMPH

Sprint ST 1050 (2005 - 2011)
 Sprint RS (from 2004)
 Speed Triple 1050 (up to 2010)
 Daytona 955i
 T 509
 T 595



For rear wheel mounting

(can be utilised from both sides!)

1 x Centering Sleeve Article No. 860e190 024

1 x Pressure Piece Article No. 850e190 007

(Supplied with Upgrade Kit 815 008 003)

HONDA

VFR 1200 X Crosstourer (2012 -)

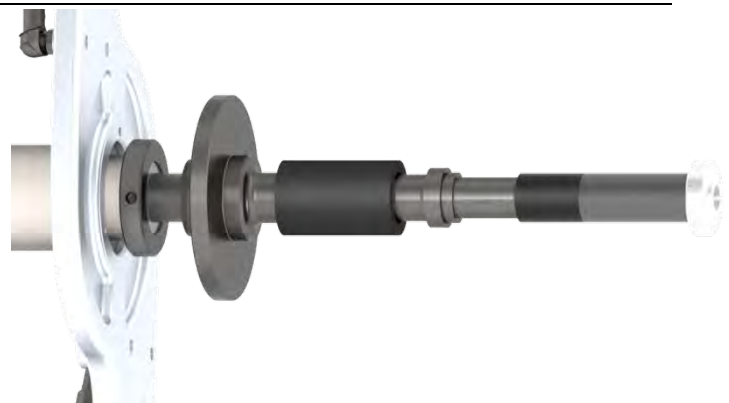

For rear wheel mounting

1 x Centering Sleeve Article No. 860e190 025

(ARTICLE ON REQUEST)

TRIUMPH

Sprint GT (2011 -)
Speed Triple (2011 -)



TRIUMPH

Tiger Explorer (2012 -)
Tiger Explorer XC (2013 -)



KTM

Super Duke (2011 -)

HOREX

VR6 (2000 -)

For rear wheel mounting (can be utilised from both sides!)

1 x Centering Flange Article No. 860e190 022

1 x Pressure Piece Article No. 850e190 007

(Supplied with Upgrade Kit 815 008 003)

MV AGUSTA

All models (from 2000)

HONDA

VFR 750
VFR 800
VFR V-TEC
VFR 800 X Crossrunner (2011 -)
CB 1000 R (2008 -)

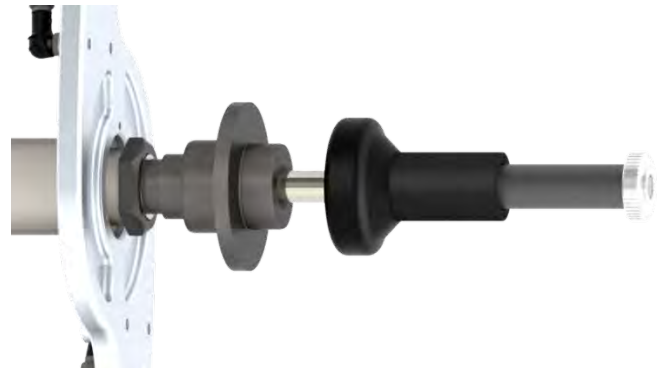

For rear wheel mounting (can be utilised from both sides!)

1 x Centering Sleeve Article No. 860e190 011

1 x Pressure Piece Article No. 850e190 007

(Supplied with Upgrade Kit 815 008 003)

KAWASAKI

H2 (2015 -)

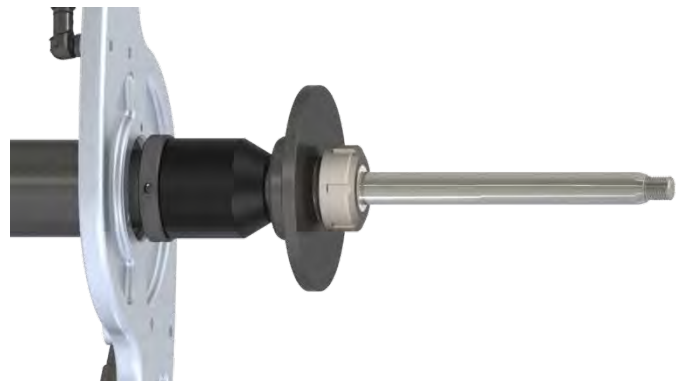

For rear wheel mounting

1 x Centering kit Article-No. 860 190 026

(ARTICLE ON REQUEST)

MV AGUSTA

For front wheel mounting
1 x Centering Sleeve Kit: Article No. 860 190 350
 (Supplied with Upgrade Kit 815 008 002)



HARLEY-DAVIDSON

- | | | |
|-----------------------|-----------------------|--------------------------|
| Bad Boy | Softail Springer | Heritage Softail Classic |
| Dyna Super Glide | Sportster 883 ST | Softail Deuce |
| Dyna Glide Low Rider | Sportster 883 Hugger | Heritage Springer |
| Dyna Glide Conv. | Sportster 1200 | Night Train |
| Dyna Wide Glide | Sportster 1200 Custom | Softail Custom |
| Electra Glide Classic | Sportster 1200 Sport | Softail Standard |
| Fat Boy | | |

For front and rear wheel mounting
2 x Pressure Piece: Article No. 860e190 260
 (Supplied with Upgrade Kit 815 008 002)



Additional for Harley Davidson
Models as of year of manufacture 2008

For front and rear wheel mounting
2 x Centering Sleeve: Article No. 860e190 250
 (Supplied with Upgrade Kit 815 008 002)



HARLEY-DAVIDSON

V-Rod

For front and rear wheel mounting
2 x Centering Sleeve: Article No. 860e190 254
 (Supplied with Upgrade Kit 815 008 002)



SUZUKI

- GSX-R 600
- GSX-R 750
- GSX-R 1000
- GSX R 1300 HAYABUSA

For front and rear wheel mounting
2 x Centering Sleeve: Article No. 860e190 320
2 x Centering Sleeve: Article No. 860e190 250
2 x Centering Sleeve: Article No. 860e190 280
 (Supplied with Upgrade Kit 815 008 002)



5. Variants for wheel centering

Application examples:



Wheel centering

Centering shaft \varnothing 14 mm
with centering cones



Wheel centering

Centering shaft \varnothing 14 or 19 mm
with centering sleeves



Wheel centering

Centering shaft \varnothing 19 mm
with the same \varnothing as the vehicle's
quick-release axle (Harley Davidson)



Wheel centering

Centering shaft \varnothing 14 or 19 mm
with special centering kit

6. ProBike spare parts and accessories

6.1 Spare parts

Gas pressure spring
Article No. DU GA150252250



Outrigger
Article No. 803e008 027
2 Units

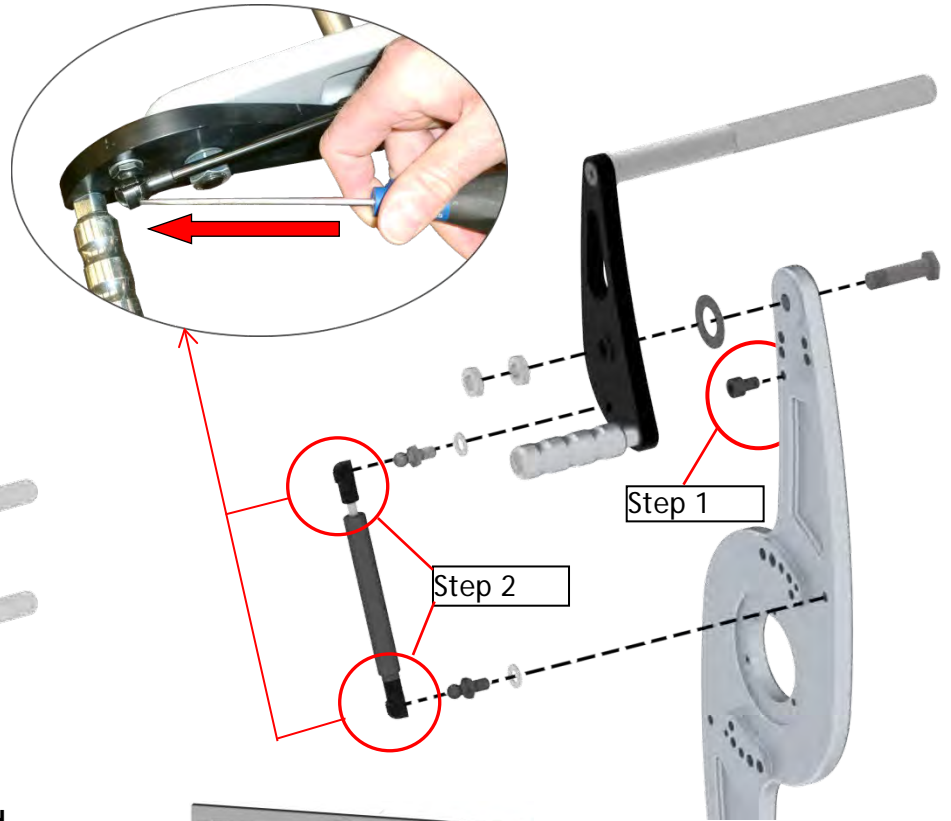

6.2. Accessories

ProBike Standard wall board
Article No.: 900 008 142

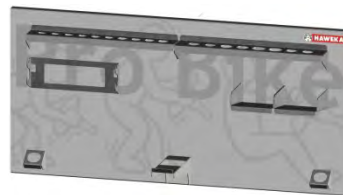

ProBike Profi wall board
Article No.: 900 008 143

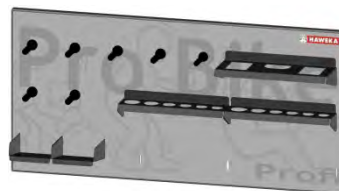

Wall board stands
Article No.: 900e008 190



Example of application

7. Overview of the Motorbike Data

The following lists do not reflect the complete range of applications for the ProBike clamping device. With this data, we only intend to provide you with some assistance for your daily work. Sorted according to manufacturer, the data which you require for the appropriate motorbike can be quickly found.

The data comes from the individual manufacturers of the motorbikes and is regularly maintained and updated by us.

Should models not be included in the list, then we request your understanding because it is not always easy to record all data and list it in printed form. This is applicable for new and also older models.

Subject to technical modifications.

Manufacturer overview:

Aprilia / BMW / Buell / Ducati / Harley Davidson / Honda / Hyosung / Indian / Kawasaki / KTM / Moto Guzzi / MV Agusta / Suzuki / Triumph / Victory / Yamaha / Zero

7.1 Motorbike Data Tables

All Ø data in [mm]

Aprilia MODEL	AXLE DIAMETER		REMARKS Special adaptors (P/No.)
	front	rear	
Classic 125 (1995-2000)	15	17	
RS 125 (1996-2012)	20	20	
RS4 (all years of construction)	15	15	
Tuono 125	15	15	
ETX 125 (1998-2000)	15	17	
RX 125 (all years of construction)	17	17	
RS 250 (1995-2002)	20	20	
Pegaso 650 (1992-1996)	17	17	
Pegaso 650 Garda (2001-2003)	17	17	
Pegaso 650 Trail (2006-2010)	17	20	
Moto 6.5 (1995-2000)	17	17	
SL 750 Shiver (2007-2016)	25	25	
Shiver 900 (2017-)	25	25	
SMV 750 Dorsoduro (2008-2016)	25	25	
SMV 750 Dorsoduro Factory (2011-2012)	25	25	
Dorsoduro Factory (2010-2012)	25	25	
Dorsoduro 900 (2017-)	25	25	
Dorsoduro 1200 (2011-2016)	25	25	
NA 850 Mana (2008-2012)	25	25	
SRV 850 (Scooter) (2013-2015)	25	30	
RSV mille/ SP (1998-2008)	20	25	
RSV 1000 R all models (2006-2011)	25	25	

Aprilia MODEL	AXLE DIAMETER		REMARKS Special adaptors (P/No.)
	front	rear	
RSV4 (all models from 2010-)	25	25	
SL 1000 Falco (1999-2004)	20	25	
RST Futura (2001-2003)	20	Mono-arm	For rear wheel: 1x860e190 012
ETV 1000 Caponord (2001-2009)	25	20	
Caponord 1200 (all models 2013-2016)	25	25	
Tuono R / Factory (2004-2001)	25	25	
Tuono V4 R APRC / Factory (2011-2014)	25	25	

BMW MODEL	AXLE DIAMETER		REMARKS Special adaptors (P/No.)
	front	rear	
G 310 R (2016-)	Follows shortly	Follows shortly	
G 450 X (2008-2011)	25	20	
F 650 all models (1993-2003)	17	17	
F 650 CS SCARVER (2002-2005)	20	Mono-arm	For rear wheel: 1x 860 190 012
G 650 GS (ab 2011-2015)	17	17	
G 650 Xchallenge (2007-2010)	20	20	
G 650 Xcountry (2007-2010)	20	20	
G 650 Xmoto (2007-2010)	20	20	
G 650 GS Sertao (2013-)	12	17	
F 700 GS (2013-)	12	14	
F 800 S (2006-2010)	25	Mono-arm	For rear wheel: 1x 860e190 020
F 800 ST (2006-2012)	25	Mono-arm	For rear wheel: 1x 860e190 020
F 800 GT (2013-2018)	14	Mono-arm	For rear wheel: 1x 860e190 020
F 800 GS (2008-2018)	20	20	
F 800 R (ab 2009)	25	20	
K 75 RT (1989-1995)	25	Mono-arm	For rear wheel: 1x 860e140 015
K 1100 LT (1990-1998)	25	Mono-arm	For rear wheel: 1x 860e140 015
K 1100 RS (1992-1996)	25	Mono-arm	For rear wheel: 1x 860e140 015
R 850 R (1998-2000)	20	Mono-arm	For rear wheel: 1x 860e140 015
R 850 C (1999-2001)	20	Mono-arm	For rear wheel: 1x 860e140 015
R 850 GS (1998-1999)	20	Mono-arm	For rear wheel: 1x 860e140 015
R nine T (2015-)	25	Mono-arm	For rear wheel: 1x 860e190 020
R 100 R Classic (1994-1996)	25	Mono-arm	For rear wheel: 1x 860e140 015
R 100 R Mystic (1993-1996)	25	Mono-arm	For rear wheel: 1x 860e140 015
R 100 RT Classic (1994-1996)	25	Mono-arm	For rear wheel: 1x 860e140 015
R 1100 R (1995-2001)	20	Mono-arm	For rear wheel: 1x 860e140 015
R 1100 RT (1996-2001)	20	Mono-arm	For rear wheel: 1x 860e140 015
R 1100 S (1998-2005)	20	Mono-arm	For rear wheel: 1x 860e140 015
R 1100 RS (1992-2001)	20	Mono-arm	For rear wheel: 1x 860e140 015
R 100 PD Classic (1990-1996)	25	Mono-arm	For rear wheel: 1x 860e140 015
R 1100 GS (1993-1999)	20	Mono-arm	For rear wheel: 1x 860e140 015

BMW MODEL	AXLE DIAMETER		REMARKS Special adaptors (P/No.)
	front	rear	
R 1150 R (2003-2006)	20	Mono-arm	For rear wheel: 1x 860e140 015
R 1150 RT (2002-2005)	20	Mono-arm	For rear wheel: 1x 860e140 015
R 1150 RT (2005)	20	Mono-arm	For rear wheel: 1x 860e190 020
R 1150 RS (2002-2005)	20	Mono-arm	For rear wheel: 1x 860e140 015
R 1150 GS (1999-2005)	20	Mono-arm	For rear wheel: 1x 860e140 015
R 1150 GS Adventure (2002-2005)	20	Mono-arm	For rear wheel: 1x 860e140 015
R 1150R Rockster (2003-2005)	20	Mono-arm	For rear wheel: 1x 860e140 015
R 1200 R (2007-2011)	25	Mono-arm	For rear wheel: 1x 860e190 020
R 1200 R Classic (2011-2014)	25	Mono-arm	For rear wheel: 1x 860e190 020
R 1200 R (2015-2018)	25	Mono-arm	For rear wheel: 1x 860e190 020
R 1200 S (ab 2006)	25	Mono-arm	For rear wheel: 1x 860e190 020
R 1200 C (1999-2004)	20	Mono-arm	For rear wheel: 1x 860e140 015
R 1200 C Independent (2004-2005)	20	Mono-arm	For rear wheel: 1x 860e140 015
R 1200 ST (2005-2008)	25	Mono-arm	For rear wheel: 1x 860e190 020
K 1200 C (2005)	20	Mono-arm	For rear wheel: 1x 860e190 020
K 1200 LT (1999-2009)	20	Mono-arm	For rear wheel: 1x 860e140 015
K 1200 S (2005-2008)	25	Mono-arm	For rear wheel: 1x 860e190 020
K 1200 R (2005-2008)	25	Mono-arm	For rear wheel: 1x 860e190 020
K 1200 R Sport (2007-2008)	25	Mono-arm	For rear wheel: 1x 860e190 020
K 1200 RS (1997-2005)	20	Mono-arm	For rear wheel: 1x 860e140 015
R 1200 RT (2005-2018)	25	Mono-arm	For rear wheel: 1x 860e190 020
K 1200 GT (2003-2005)	20	Mono-arm	For rear wheel: 1x 860e140 015
K 1200 GT (ab 2006)	25	Mono-arm	For rear wheel: 1x 860e190 020
R 1200 GS (2004-2012)	25	Mono-arm	For rear wheel: 1x 860e190 020
R 1200 GS (2013-2018)	25	Mono-arm	For rear wheel: 1x 860e190 020
R 1250 R (2019-)	25	Mono-arm	For rear wheel: 1x 860e190 020
R 1250 RT (2019-)	25	Mono-arm	For rear wheel: 1x 860e190 020
R 1250 RS (2019-)	25	Mono-arm	For rear wheel: 1x 860e190 020
R 1250 GS (2019-)	20	Mono-arm	For rear wheel: 1x 860e190 020
K 1300 R (2009-2015)	25	Mono-arm	For rear wheel: 1x 860e190 020
K 1300 GT (2009-2011)	25	Mono-arm	For rear wheel: 1x 860e190 020
K 1300 S (2009-2015)	25	Mono-arm	For rear wheel: 1x 860e190 020
K 1600 B/Grand America (2018-)	25	Mono-arm	
K 1600 GTL (2011-)	25	Mono-arm	For rear wheel: 1x 860e190 020
K 1600 GT (2011-)	25	Mono-arm	For rear wheel: 1x 860e190 020
K 1600 Sport (2014-2016)	25	Mono-arm	For rear wheel: 1x 860e190 020
HP2 Enduro (2006-2007)	25	Mono-arm	For rear wheel: 1x 860e190 020
HP2 Megamoto (2007-2009)	25	Mono-arm	For rear wheel: 1x 860e190 020
HP2 Sport (2007-2010)	25	Mono-arm	For rear wheel: 1x 860e190 020
HP4 (2013-2014)	25	28	
S 1000 RR (2010-)	25	28	
S 1000 R (2014-)	25	28	
S 1000 XR (2015-)	25	28	

Buell MODEL	AXLE DIAMETER		REMARKS Special adaptors (P/No.)
	front	rear	
M2 Cyclone (1997-2002)	17	25	
S1 Lightning/White L.	17	25	
X1 Lightning (1999-2002)	17	25	
S3/S3 Thunderbolt (1997-1999)	17	25	
Firebolt XB9R (2002-2007)	25	30	
Firebolt XB9S (2003-2007)	25	30	
Lightning XB12S (2004-2010)	25	30	
Firebolt XB12 R (2004-2007)	25	30	
Lightning City XB9SX (2003-2007)	25	30	
Ulysses XB12X (2006-2010)	25	30	
Lightning Long XB12S (2006-2007)	25	30	
1125 R (2008-2010)	25	30	
1125 CR (2009-2010)	25	30	

Ducati MODEL	AXLE DIAMETER		REMARKS Special adaptors (P/No.)
	front	rear	
Scrambler Sixty2 399ccm (2016-)	Follows shortly	Follows shortly	
Scrambler all 803ccm (2015-)	Follows shortly	Follows shortly	
Monster 600 (1994-2001)	17	25	
Monster 620 (2002-2006)	17	25	
Monster 696 (2008-2014)	25	25	
Monster 750 (1996-2002)	17	25	
Monster 796 (2010-2014)	25	Mono-arm	For rear wheel: 1x 860e190 004
Monster 800 (2003-2007)	25	25	
Monster 797 (2017-)	25	25	
Monster 1000 (2003-2008)	25	25	
Monster 1100/S/EVO (2009-2014)	25	Mono-arm	For rear wheel: 1x 860e190 004
Monster S2R 800 (2005-2007)	25	Mono-arm	For rear wheel: 1x 860e190 004
Monster S4R 1000 (2007-2008)	25	Mono-arm	For rear wheel: 1x 860e190 004
Monster S2R 1000 (2007-2008)	25	Mono-arm	For rear wheel: 1x 860e190 004
Monster 821 (2014-2015)	25	25	
Monster 900 (1993-2001)	17	25	
Monster 1200 S / R (2014-)	25	Mono-arm	For rear wheel: 1x 860e190 004
Hypermotard 796 (2010-2013)	25	Mono-arm	For rear wheel: 1x 860e190 004
Hypermotard 1100 / 1100 S (2007-2012)	25	Mono-arm	For rear wheel: 1x 860e190 004
Hypermotard 1100 Evo SP (2010-2012)	25	Mono-arm	For rear wheel: 1x 860e190 004
Hypermotard SP (2013-2015)	25	Mono-arm	For rear wheel: 1x 860e190 004
Hypermotard 939 und SP (2016-)	25	Mono-arm	For rear wheel: 1x 860e190 004
Hypermotard 950 und SP (2019-)	25	Mono-arm	For rear wheel: 1x 860e190 004
Hyperstrada (2013-2015)	25	Mono-arm	For rear wheel: 1x 860e190 004

Ducati MODEL	AXLE DIAMETER		REMARKS
	front	rear	Special adaptors (P/No.)
Hyperstrada 939 (2016-)	25	Mono-arm	For rear wheel: 1x 860e190 004
Streetfighter 848 (2012-2015)	25	Mono-arm	For rear wheel: 1x 860e190 004
Streetfighter /S 1100 (2010-2012)	25	Mono-arm	For rear wheel: 1x 860e190 004
Streetfighter 1098 (2012-2013)	25	Mono-arm	For rear wheel: 1x 860e190 004
SS 750 ie Nuda/Carenata (2001-2003)	17	25	
748 all models (1995-2003)	25	Mono-arm	For rear wheel: 1x 860e190 004
749 all models (2003-2007)	25	30	
848 all models (2008-2013)	25	Mono-arm	For rear wheel: 1x 860e190 004
899 Panigale (2014-2015)	25	25	
SS 900 ie Nuda/Carenata (1990-2002)	17	25	
ST 2 (1997- 2003)	25	25	
ST 4 (1997-2003)	25	25	
ST 3 (2004-2007)	25	25	
Supersport 800 (2003-2004)	17	25	
Supersport 1000 (2003-2007)	17	25	
Supersport (2017-)	25	Mono-arm	For rear wheel: 1x 860e190 004
959 Panigale (ab 2017-)	25	25	
916 all models (1995-2003)	25	Mono-arm	For rear wheel: 1x 860e190 004
996 all models (1998-2001)	25	Mono-arm	For rear wheel: 1x 860e190 004
998 all models (2002-2003)	25	Mono-arm	For rear wheel: 1x 860e190 004
999 all models (2003-2006)	25	30	
1098 all models (2007-2009)	25	Mono-arm	For rear wheel: 1x 860e190 004
1198 all models (2009-2011)	25	Mono-arm	For rear wheel: 1x 860e190 004
1199 Panigale all models (2012-2017)	25	Mono-arm	For rear wheel: 1x 860e190 004
1299 Panigale all models (2016-2018)	25	Mono-arm	For rear wheel: 1x 860e190 004
Desmosedici RR (2007-2008)	25	30	
Multistrada 620 (2005-2006)	25	25	
Multistrad 950 (2017-)	25	25	
Multistrada 1000 all models (2003-2006)	25	Mono-arm	For rear wheel: 1x 860e190 004
Multistrada 1100 /1100 S(2007 - 2009)	25	Mono-arm	For rear wheel: 1x 860e190 004
Multistrada 1200 all models (2011-)	25	Mono-arm	For rear wheel: 1x 860e190 004
Multistrada 1200 Enduro Pro (2019-)	25	25	
Multistrada 1260 all models (2018-)	25	25	
Scrambler 1100 all models (2018-)	25	25	
GT 1000 (2007-2010)	25	25	
Diavel (2011-)	25	Mono-arm	For rear wheel: 1x 860e190 004
XDiavel und S (2016-)	25	Mono-arm	For rear wheel: 1x 860e190 004

Harley-Davidson MODEL	AXLE DIAMETER		REMARKS
	front	rear	Special adaptors (P/No.)
Bad Boy (1995-1997)	19,05	19,05	2 x Spacing sleeve 860e190 260
Sportster 883 Standard (1989-2003)	19,05	19,05	2 x Spacing sleeve 860e190 260

Harley-Davidson MODEL	AXLE DIAMETER		REMARKS
	front	rear	Special adaptors (P/No.)
Sportster 883 Hugger (1987-2003)	19,05	19,05	2 x Spacing sleeve 860e190 260
Sportster 883 Custom (2005)	19,05	19,05	2 x Spacing sleeve 860e190 260
Sportster 883/ Low (2005)	19,05	19,05	2 x Spacing sleeve 860e190 260
Sportster 883 (from 2008)	25	25	
Sportster 883 Roadster (from 2008)	25	25	
Sportster 883 (from 2008)	25	25	
Sportster 883/1200 Custom (from 2008)	25	25	
Sportster 1200 (all models 1988-2008)	19,05	19,05	2 x Spacing sleeve 860e190 260
Sportster 1200 Low (from 2008)	25	25	
Sportster 1200 Nightster (from 2008)	25	25	
Sportster 1200 Roadster (from 2008)	25	25	
V-ROD (all models 2002-2007)	25,4	25,4	1x 860e190 254 /860 190 014
V-Rod (from 2008)	25	25	
Night Rod Special (from 2008)	25	25	
XR 1200 (from 2008)	25	25	
Rocker C (from 2008)	25	25	
Softail Night Train (1999-2007)	19,05	19,05	2 x Spacing sleeve 860e190 260
Softail Night Train (from 2008)	25	25	
Softail Heritage Springer (1997-2003)	19,05	19,05	2 x Spacing sleeve 860e190 260
Softail Heritage Classic (1991-2004)	19,05	19,05	2 x Spacing sleeve 860e190 260
Softail Heritage Classic (from 2008)	25	25	
Fat Boy (all models 1991-2007)	19,05	19,05	2 x Spacing sleeve 860e190 260
Fat Boy (from 2008)	25	25	
Softail Deluxe (from 2008)	25	25	
Softail Standard (1985-)	19,05	19,05	2 x Spacing sleeve 860e190 260
Softail Springer (1991-2007)	19,05	19,05	2 x Spacing sleeve 860e190 260
Softail Deuce (2001-2007)	19,05	19,05	2 x Spacing sleeve 860e190 260
Softail Deluxe (from 2005)	19,05	19,05	2 x Spacing sleeve 860e190 260
Screamin Eagle Softail Springer (2007)	19,05	19,05	2 x Spacing sleeve 860e190 260
Screamin Eagle Softail Springer (2008)	25	25	
Softail Custom (1986-)	19,05	19,05	2 x Spacing sleeve 860e190 260
Softail Custom (from 2008)	25	25	
Dyna Glide Low Rider (1993-1997)	19,05	19,05	2 x Spacing sleeve 860e190 260
Dyna Glide Conv. (1996-2002)	19,05	19,05	2 x Spacing sleeve 860e190 260
Dyna Wide Glide (1985-2007)	19,05	19,05	2 x Spacing sleeve 860e190 260
Dyna Low Rider (from 2008)	25	25	
Dyna Super Glide (1982-2007)	19,05	19,05	2 x Spacing sleeve 860e190 260
Dyna Super Glide T-Sport (2002-2005)	19,05	19,05	2 x Spacing sleeve 860e190 260
Dyna Super Glide Custom (1992-2007)	19,05	19,05	2 x Spacing sleeve 860e190 260
Dyna Super Glide Custom (ab 08)	25	25	
Dyna Street Bob (from 2008)	25	25	
Dyna Fat Bob (from 2008)	25	25	
Screamin Eagle Dyna (from 2008)	25	25	

Harley-Davidson MODEL	AXLE DIAMETER		REMARKS
	front	rear	Special adaptors (P/No.)
Electra Glide (all models)	19,05	19,05	2 x Spacing sleeve 860e190 260
Electra Glide Standard (from 2008)	25	25	
Street Glide (from 2008)	25	25	
Road King (all models)	19,05	19,05	2 x Spacing sleeve 860e190 260
Road King (from 2008)	25	25	
Road King Classic (from 2008)	25	25	
Ultra Classic Glide (from 2008)	25	25	
As of year of construction 2008 all axes ø25 mm			

Honda MODEL	AXLE DIAMETER		REMARKS
	front	rear	Special adaptors (P/No.)
XR 125 L (2003-2008)	12	17	
CA 125 Rebel (1995-2000)	15	15	
CLR 125 (1998-2000)	15	15	
VT 125 C/C2 Shadow (2001-2008)	15	15	
NSR 125 R (1994-2003)	15	15	
CBR125 R (2008-)	12	17	
CBR 125 R (2011-)	12	15	
CMX 250 Rebel (1996-1999)	15	15	
CRF 250 L / M (2013-)	15	17	
CRF 250 Rally (2017-)	17	17	
CBR 250 R (2011-2012)	15	17	
CBR 300 R (2015-2016)	15	17	
CB 300 R (2017-)	15	17	
CB 1 (1989-1990)	20	20	
XR 400 R (1996-2002)	17	17	
CRF 450 L (2019-)	20	20	
VFR 400 R (1986-1991)	20	Mono-arm	For rear wheel: 1x 860e190 011
CB 500 (1994-)	15	17	
GB 500 (1989-1990)	15	17	
CB 500 F (2013-)	17	17	
CBR 500 R (2013-)	17	17	
CB 500 X (2013-)	17	17	
CMX 500 Rebell (2017-)	17	17	
Hornet 600 alle Typen (1998-2013)	20	20	
CB 650 F (2016-)	20	20	
CB 650 R (2019-)	20	20	
CBF 600 (2004-2013)	20	20	
CBR 600 F (1987-2012)	20	20	
CBR 600 RR (2003-2016)	20	25	
CBR 650 F (2015-)	20	20	
XR 600 (1985-2000)	17	20	
XL 600 V Transalp (1987- 2000)	15	17	
XL 650 V Transalp (2001-2006)	17	17	

Honda MODEL	AXLE DIAMETER		REMARKS Special adaptors (P/No.)
	front	rear	
XL 700 V Transalp (2007-2011)	17	17	
FMX 650 (2005-2007)	17	17	
VT 600 C Shadow (1988-2000)	20	17	
Deauville (2006-2012)	20	20	
DN-01 (2008 - 2011)	20	Mono-arm	For rear wheel: 1x 860 190 016
SLR 650 (1997-1998)	20	17	
NTV 650 (1988-1996)	20	Mono-arm	For rear wheel: 1x 860e190 018
NX 650 Dominator (1988-2000)	15	17	
Vigor 650 (1999-2000)	15	17	
CTX 700 N (2015-)	20	20	
Integra (2012-2013)	20	20	
NC 700 S/ NC700 X (2012-2015)	20	20	
NC 750 S/ NC750 X (2016-)	20	20	
X-ADV (2017-)	20	20	
CB 750 Seven Fifty (1992-2000)	20	17	
XRV 650/750 Africa Twin (1988-2003)	17	17	
VT 750 (1987-1997)	15	20	
VT 750 (1997-2016)	20	20	
VF 750 C/C2 Shadow ACE (1982-2000)	20	20	
Crossrunner VFR 800 X (2011-2014)	20	Mono-arm	FOR REAR WHEEL: 1x 860e190 011
Crossrunner VFR 800 X (2015-)	20	Mono-arm	FOR REAR WHEEL: 1x 860e190 011
VFR 750 F (1986-1997)	20	Mono-arm	For rear wheel: 1x 860e190 011
VFR 800 also V-TEC (1998-2010)	20	Mono-arm	For rear wheel: 1x 860e190 011
VFR 800 (2014-)	20	Mono-arm	
VFR 1200 (2010-2016)	25	Mono-arm	For rear wheel: 1x 860e190 024
VFR 1200 X Crosstourer (2012-)	20	Mono-arm	For rear wheel: 1x 860e190 025
CB 900 F HORNET (2002-2006)	20	17	
CB 1000 R (2008-2017)	20	Mono-arm	For rear wheel: 1x 860e190 011
CB 1000 R (2018-)	20	Mono-arm	
CB 1000 F Super Four (1993-1996)	20	20	
CB 1300 (2003-2013)	20	25	
CBF 1000 (2006-)	20	20	
CBF 1000 F (2010- 2016)	20	20	
CBR 1000 F (1987-2000)	20	20	
CBR 1100 XX S.Blackbird (1997-2008)	20	20	
CBR 900 RR (1992-2003)	20	20	
CBR 1000 RR Fireblade (2006-)	25	25	
CBR 1000 RR Fireblade (2017-)	25	28	
VTR 1000 SP1/SP2 (2001-2006)	22	25	
XL 1000 V Varadero (1999-2011)	20	20	
CRF 1000 L Africa Twin (2016-)	20	20	
VTR 1000 Firestorm (1997-2004)	20	20	
ST 1100 Pan European (1990-2001)	20	20	
VT 1100 C/C2/C3 (1988-2000)	20	20	
CB 1100 SF X-11 (2000-2003)	20	20	
CB 1100 (2015-)	20	20	

Honda MODEL	AXLE DIAMETER		REMARKS Special adaptors (P/No.)
	front	rear	
CB 1100 EX (2015-)	20	20	
CB 1300 (2005-2013)	20	25	
CTX 1300 DX (2014-2016)	20	20	
VTX 1300 (2003-2007)	20	20	
VT 1300 CX Fury (2010-2017)	20	25	
GL 1500 Goldwing (1988-2003)	20	20	
GL 1800 Goldwing (2001-)	20	Mono-arm	For rear wheel: 1x 860e190 018
GL 1800 Gold Wing und Touring (2018-)			
GL 1800 Goldwing (F6 Typen) (2013-)	20	Mono-arm	For rear wheel: 1x 860e190 018
GL 1500 F6 C Valkyrie (1997-2003)	20	20	
Pan European ST1300 (2002-2017)	25	20	

Hyosung MODEL	AXLE DIAMETER		REMARKS Special adaptors (P/No.)
	front	rear	
XRX 125 (1999-)	15	15	
XRX 125 SM (2008-)	15	17	
GT 125 Naked (2009- 2012)	15	17	
GV 125 (2000-2010)	15	15	
GDI250i	15	17	
GT 250 (all models 2004-)	15	17	
GV 250i Aquila (all models 2001-)	15	17	
GT 650i (all models 2004-)	15	17	
GV 650i (all models 2006-)	15	17	
ST 700i (2011-)	15	17	

Indian MODEL	AXLE DIAMETER		REMARKS Special adaptors (P/No.)
	front	rear	
Chief Classic (2012-)	20	20	
Chief Dark Horse (2012-)	20	20	
Chief Vintage (2012-)	20	20	
Chieftain Classic (2014-)	20	20	
Chieftain Dark Horse (2016-)	20	20	
Chieftain Limited (2018-)	20	20	
FTR 1200 (2019-)	25	25	
FTR 1200 S (2019-)	25	25	
Roadmaster (2015-)	20	20	
Scout (2015-)	20	20	
Scout ABS (2018-)	20	20	
Scout Bobber (2018-)	20	20	
Scout Sixty (2016-)	20	20	
Springfield (2016-)	20	20	
Springfield Dark Horse (2018-)	20	20	

Kawasaki MODEL	AXLE DIAMETER		REMARKS Special adaptors (P/No.)
	front	rear	
BN125 A Eliminator (1998-2007)	15	15	
KMX 125 (1992-2003)	17	17	
KLX 125 (2003-2006)	10	15	
KLX 125 (2010-2016)	12	12	
D-Tracker 125 (2010-)	12	15	
BJ 250 A/B (1994-1999)	15	17	
EL 250 (all types 1988-2003)	15	17	
KLR 250 (1984-1992)	15	17	
KLX 250 (all types 1993-2017)	15	20	
Z300 (2015-2018)	15	17	
Z 400 (2018-)	17	17	
Ninja 250 R (2008-2012)	15	17	
Ninja 300 (2013-2018)	15	17	
ZXR 400 (all types 1989-1999)	20	20	
Ninja 400 (2018-)	17	17	
EN 500 (all types 1990-2003)	15	17	
GPZ 500 S (all types 1987-2003)	15	17	
ER 5 Twister (all types 1997-2006)	15	17	
KLE 500 (1991-2007)	15	17	
ZR 550 Zephyr (all types 1984-1999)	15	17	
GPZ 550 (all types 1984-1999)	15	17	
GPZ 600 R (19985-1990)	15	17	
GPX 600 R (1988-1996)	15	17	
ZZR 600 (1990-1992)	15	17	
ZZR 600 (1993-2006)	20	20	
Ninja ZX-6R (1998-2002)	25	25	
Ninja ZX-6R (1995-1997)	20	20	
Ninja ZX-6R 636 (2002-2006)	25	25	
Ninja ZX-6R (2007-2012) 600ccm	25	25	
Ninja ZX-6-RR (2003-2006) 600ccm	25	25	
Ninja ZX-6R 636 (2013-)	25	25	
ER-6n (2006-2016)	20	20	
ER-6f (2006-2016)	20	20	
ZL 600 (1986-1997)	15	17	
W 650 (all types 1999-2005)	15	17	
KLR 650 C (1987-2004)	15	17	
KLX 650 (all types 1993-2001)	15	20	
KLE 650 Versys (2007-2014)	20	20	
Z 650 (2017-)	20	20	
Versys 650 (2015-)	20	20	
Vulcan S 650ccm (2015-)	20	20	

Kawasaki MODEL	AXLE DIAMETER		REMARKS Special adaptors (P/No.)
	front	rear	
Ninja 650	20	20	
ZR 750 J: Z 750 (2004-2006)	20	20	
ZR 750 L: Z 750 (2007-2011)	20	20	
ZR 750 NPA: Z 750 (2011-2012)	25	20	
ZR 750 C Zephyr (1991-1995)	17	17	
ZR 750 D Zephyr (1996-1999)	15	17	
ZR 750 FF: ZR-7 750 F (1999-2004)	17	20	
ZR 750 FH: ZR-7 750 S (2001-2004)	17	20	
ZX 750 F: GPX 750 R (1987-1988)	15	20	
ZX 750 G: GPZ 750 R (1985)	15	17	
ZX 750 L: ZXR 750 L (1993-1995)	25	25	
ZX 750 P: ZX-7R 750 P Ninja (1996-2002)	25	25	
ZR800 AA: Z 800 (2013-)	20	20	
EJ800A: W 800 (2011-2016)	17	17	
W 800 (2019-)	17	20	
VN 800 A: VN 800 A (1995-1999)	15	17	
VN 800 B: VN 800 B Classic (1996-1998)	20	17	
VN 800 AB: VN 800 Classic (1999-2006)	20	17	
VN 800 CE: VN 800 E Drifter (1999-2003)	20	17	
ZX 900 A: GPZ 900 R (1984-1994)	15	17	
Ninja ZX 9 R C+D (2006-)	20	20	
VN 900 Classic (2006-)	20	20	
VN 900 C Custom (2007-)	20	20	
Vulcan 900 (all Types 2015-)	20	20	
ZX 900 B: ZX-9R 900 B Ninja (1994-1997)	25	25	
ZX 900 A: GPZ 900 R (1984-1994)	15	17	
ZX 900 B: ZX-9R 900 B Ninja (1994-1997)	25	25	
ZX 900 C: ZX-9R 900 C Ninja (1998-1999)	20	20	
ZX 900 D: ZX-9R 900 D (1998-1999) Kat	20	20	
ZX 900 E: ZX-9R 900 E Ninja (2000-2003)	25	25	
ZX 900 F: ZX-9R 900 F Ninja (2002-2003)	25	25	
Z 900 (2017-)	20	20	
Z 900 RS (2018-)	20	20	
1000 GTR (1986-1993)	15	20	
1000 GTR (1994-2003)	17	20	
1400 GTR (2007-)	25	20	
KLV 1000 (2004-2006)	20	20	
KLZ 1000 Versys A (2012-)	25	20	
Z 1000 (2003-2009)	25	25	
Z 1000 (2010-)	20	20	
Z 1000 SX (2011-)	20	20	
ZX 1000 A: ZX-10 (1986-1988)	15	20	
ZR 1100 A+B: Zephyr (1992-1997)	17	20	

Kawasaki MODEL	AXLE DIAMETER		REMARKS Special adaptors (P/No.)
	front	rear	
ZR 1100 C: ZXR1100 (1997-2000)	25	20	
ZX 1100 A: GPZ 1100 Uni-Trak (1981-1985)	15	20	
ZX 1100 C: ZZR1100 C (1990-1992)	20	20	
ZX 1100 D: ZZR1100 D (1993-1997)	25	20	
ZX 1100 G: ZZR-1100 (1998-2001)	25	20	
ZX-10 R 1000 C Ninja (2004-2006)	20	20	
ZX-10 R 1000 D/E/F/J/K Ninja (2006-2010)	25	20	
ZX-10 R (2015-)	25	25	
Ninja H2 / H2-R (2015-)	25	Mono-arm	For rear wheel: 860 190 026
Ninja ZX-12R (2000-2006)	25	25	
ZRX 1200 (all Types 2001-2006)	25	20	
ZZR 1400 (2006-)	25	25	
VN-15 (all Types 1988-1995)	15	20	
VN 1500 Classic (all Types 1996-2004)	20	20	
VN 1500 Drifter (1999-2003)	20	20	
VN 1500 Mean Streak (2002-2003)	25	20	
VN 1600 Classic/Mean Streak/Tourer (2003-2008)	25	20	
VN 1700 (all 2009-2016)	25	20	
VN 2000 (2004-2010)	25	20	

KTM MODEL	AXLE DIAMETER		REMARKS Special adaptors (P/No.)
	front	rear	
125 EXE Enduro (2000-2001)	17	20	
125 EXE Supermoto (2000-2001)	17	20	
125 LC2 (1996-2000)	17	20	
Sting 125 (1997-2000)	17	20	
Duke 125 (2011-)	15	15	
Duke 200 (2012-)	15	15	
Duke 390 (2013-)	15	15	
RC 390 (2014-)	15	15	
Freeride 250 (2014-2017)	25	25	
Freeride 250 F (2018-)	25	25	
Freeride 350 (2012-2017)	22	20	
LC4 400 (1998)	17	20	
LC4 620 (all types 1994-2001)	17	20	
LC4 620 Supermoto (1998)	17	20	
LC4 640 Enduro (1998-2006)	17	20	
LC4 640 Adventure R (1998-2000)	17	25	
LC4 625 SC Supermoto (2002)	20	25	
LC4 625 SXC (2003-)	30	25	
Duke I 620 (1994-1998)	17	20	

KTM MODEL	AXLE DIAMETER		REMARKS Special adaptors (P/No.)
	front	rear	
Duke II 640 E (1998-2007)	17	20	
690 Enduro (2008-2010)	30	25	
690 Enduro (2009-)	30	25	
690 Supermoto (2007-2010)	30	25	
690 SMC /R (2008-)	30	25	
690 Duke (2008-)	30	25	
690 Duke R (2010-)	30	25	
790 Duke (2018-)	30	30	
790 Adventure (2019-)	30	25	
950 Adventure (LC8) (2003-2006)	30	25	
950 Supermoto (2005-2008)	30	25	
950 Super Enduro R (2006-2008)	30	25	
990 Superduke (2004-2012)	26	25	
990 Adventure /S (2006-2013)	26	25	
990 Supermoto R (2009-2014)	26	25	
990 Supermoto T (2009-2013)	26	25	
990 Adventure/ R (2009-2012)	26	25	
1050 Adventure (2015-2016)	30	25	
1090 Adventure (2017-2018)	30	25	
1190 Adventure / R (2013-2016)	30	25	
1190 RC8 /R (2007-2011)	26	30	
1190 RC8 R Track (2011-2012)	30	30	
1290 R Superduke (2014-)	30	Mono-arm	Mono-arm:1x 860e190 022
1290 Super Duke GT (2016-)	30	Mono-arm	Mono-arm:1x 860e190 022
1290 Super Adventure T	30	25	
1290 Super Adventure S + R (2017-)	30	25	

Moto Guzzi MODEL	AXLE DIAMETER		REMARKS Special adaptors (P/No.)
	front	rear	
Breva 750 Touring (2006-2008)	20	20	
Nevada 750 (1993-2015)	20	20	
Norge 850 (2007)	25	no data	
V7 Classic (2008-2012)	20	20	
V7 Cafe Classic (2009-2012)	20	20	
V7 Special (2012- 2014)	20	20	
V7 II Stone special (2015-)	20	20	
V7 Racer (2011-2014)	20	20	
V7 II Stornello (2016-)	20	20	
Griso 8V (2007-2013)	25	Mono-arm	For rear wheel: 860e140 015
V85 + TT (2018-)	25	20	
Bellagio 940 (2007-2010)	25	no data	

Moto Guzzi MODEL	AXLE DIAMETER		REMARKS Special adaptors (P/No.)
	front	rear	
V9 Bobber (2016-)	20	20	
V9 Roamer 850 (2016-)	20	20	
V9 Sport	20	20	
California 1100 (1994-1997)	20	20	
California 1100 EV/Spezial (1997-2005)	20	20	
California 1100 i Jackal (1999-2001)	20	20	
California Classic Touring (2006-2011)	20	20	
California 1400 Touring (2012-2014)	25	25	
California 1400 Custom (2013-)	25	25	
California Vintage (2006-2013)	25	20	
California 90 (2012-2014)	20	20	
California 1400 Touring / SE (2015-)	25	25	
California 1400 Custom/Audace/Eldorado (2015-)	25	25	
Griso 1100 (2005-2008)	25	25	
1000 Daytona (all types 1992-1998)	20	20	
1000 Quota (1992-1997)	17	20	
1100 Quota (1998-2002)	20	20	
1100 Sport (1998-1999)	20	20	
1100 Sport injection (1996-1999)	20	20	
V10 Centauro/Sport /GT (1997-1999)	20	20	
V11 Sport (1999-2004)	20	20	
1200 Sport (2006-2007)	25	no data	
1200 Sport 4V (2008-2014)	25	Mono-arm	For rear wheel: 860e140 015
Norge 1200 (2006-2015)	25	no data	
Norge 1200 IE 8V (2010-2015)	25	no data	
Breva 1200 (2008-2011)	25	Mono-arm	For rear wheel: 860e140 015
Stelvio 1200 (2008-)	25	Mono-arm	For rear wheel: 860e140 015
Stelvio 1200 8V NTX (2011- 2015)	25	Mono-arm	For rear wheel: 860e140 015

MV Agusta MODEL	AXLE DIAMETER		REMARKS Special adaptors (P/No.)
	front	rear	
F3 Brutale 675 (2012-)	35	Mono-arm	For rear wheel: 1x 860e190 011
F3 675 (all Types 2012-)	35	Mono-arm	For rear wheel: 1x 860e190 011
F3 800 (2014 -)	35	Mono-arm	For rear wheel: 1x 860e190 011
Rivale 800 (2014-)	35	Mono-arm	For rear wheel: 1x 860e190 011
Stradale 800 (2015-)	35	Mono-arm	For rear wheel: 1x 860e190 011
Brutale 800 all Types (2015-)	35	Mono-arm	For rear wheel: 1x 860e190 011
Turismo Veloce 800 / Lusso (2015-)	35	Mono-arm	For rear wheel: 1x 860e190 011
Superveloce 800	35	Mono-arm	For rear wheel: 1x 860e190 011
F3 800 / RC (2015-)	35	Mono-arm	For rear wheel: 1x 860e190 011
F4 750 Brutale (2003-2005)	35	Mono-arm	For rear wheel: 1x 860e190 011

MV Agusta MODEL	AXLE DIAMETER		REMARKS Special adaptors (P/No.)
	front	rear	
Brutale 910 (all Types 2006-2009)	35	Mono-arm	For rear wheel: 1x 860e190 011
Brutale 920 (2012-)	35	Mono-arm	For rear wheel: 1x 860e190 011
Brutale 989 R (2009-2010)	35	Mono-arm	For rear wheel: 1x 860e190 011
Brutale 990 R (2010-2011)	35	Mono-arm	For rear wheel: 1x 860e190 011
Brutale 1000 (2018-)	35	Mono-arm	For rear wheel: 1x 860e190 011
Brutale 1078 RR (2009-2010)	35	Mono-arm	For rear wheel: 1x 860e190 011
Brutale 1090 RR (2010-)	35	Mono-arm	For rear wheel: 1x 860e190 011
F4 750 (all Types 2000-2005)	35	Mono-arm	For rear wheel: 1x 860e190 011
F4 1078 RR 312 (2009-2010)	35	Mono-arm	For rear wheel: 1x 860e190 011
F4 1000 (all Types 2004-)	35	Mono-arm	For rear wheel: 1x 860e190 011

Suzuki MODEL	AXLE DIAMETER		REMARKS Special adaptors (P/No.)
	front	rear	
DR 125 (all Types 1982-)	12	15	
GN 125 (1994-1999)	12	15	
GZ 125 Marauder (1998-)	12	15	
RV 125 VanVan (2003-)	15	15	
VL 125 Intruder (2001-2008)	15	15	
Van Van 200 (2015-2017)	15	15	
GN 250 (1985-1999)	15	15	
GZ 250 Marauder (1999-2008)	15	15	
VL 250 Intruder (2000-2007)	15	15	
Inazuma 250 (all types 2013-)	15	17	
DR 350 (all types 1990-1997)	15	20	
DR-Z 400 (all types 2001-2008)	20	20	
GSF 400 Bandit (1991-1995)	15	17	
RG 500 Gamma (1985-1989)	15	17	
GS 500 (all types 1979-2008)	15	17	
SVF 650 Gladius (2009-)	17	20	
GSF 600 Bandit (1995-2004)	17	20	
Bandit 650 (all types 2005-2006)	17	20	
Bandit 650 (all types 2007-2016)	20	20	
GSR 600 (2006-2011)	22	25	
GSX 600 F (1988-2001)	15	17	
GSX 650 F (2008-2016)	20	20	
GSX-R 600 (1997-2000)	25	32	Front and rear wheel: 860 190 009
GSX-R 600 (2001-2003)	25	28	Front and rear wheel: 860 190 009
GSX-R 600 (2004-2005)	25	28	Front and rear wheel: 860 190 009
GSX-R 600 (2006-2008)	25	28	Front and rear wheel: 860 190 009
GSX-R 600 (2009-2017)	25	28	Front and rear wheel: 860 190 009
RF 600 (all types 1993-1996)	15	25	
DR 600 S/R (1986-1989)	15	17	

Suzuki MODEL	AXLE DIAMETER		REMARKS Special adaptors (P/No.)
	front	rear	
AN 650 (Roller) (2002-)	17	Spline shaft	
DR 650 R/RE/RSE (1990-1995)	15	17	
DR 650 SE (1996-2000)	17	20	
V-Strom 650 (2004-)	17	20	
XF 650 Freewind (1997-2002)	17	20	
LS 650/P Savage (1986-2000)	15	17	
SV 650 (all types 1999-2002)	17	17	
SV 650 (all types 2003-)	17	20	
VS 600 GL Intruder (1995-1997)	15	17	
GSR 750 (2011-2016)	22	25	
GSX 750 (1980-1983)	15	20	
GSX 750 (1998-2003)	20	20	
GSX-S 750 (2017-)	22	25	
GSX 750 F (1989-2006)	15	17	
GSX-R 750 (1985-1988)	15	20	
GSX-R 750 R (1986)	15	25	
GSX-R 750 (1987)	17	20	
GSX-R 750 (1988-1995)	20	20	Front and rear wheel: 860 190 009
GSX-R 750 (1996-1999)	25	32	Front and rear wheel: 860 190 009
GSX-R 750 (2000-2010)	25	28	Front and rear wheel: 860 190 009
GSX-R 750 (2011-2017)	22	25	
DR 750/800 S BIG (1988-1999)	15	17	
VX 800 (1990-1997)	15	17	
VZ 800 Marauder (all types 1997-)	17	17	
VS 800 GL Intruder	15	17	
RF 900 R/RS2 (1994-1997)	20	20	
GSX-R 1000 (2001-2008)	25	28	Front and rear wheel: 860 190 009
GSX-R 1000 (2009-2011)	25	32	Front and rear wheel: 860 190 009
GSX-R 1000 (2012- 2014)	25	28	Front and rear wheel: 860 190 009
GSX-R 1000 ABS (2015-)	25	28	Front and rear wheel: 860 190 009
DL 1000 V-Strom (2002-2010)	20	20	
V-Strom 1000 (2014-)	25	28	
SV 1000 /1000 S (2003-2005)	25	28	
TL 1000 S/R (1997-2000)	25	32	
GSX-S 1000 / F (2015-)	22	28	
GSX 1100 G (1984-1986)	15	17	
GSX 1100 F (1988-1996)	17	20	
GSX-R 1100 (1986-1988)	15	20	
GSX-R 1100 (1989-1997)	20	20	
GSF 1200 Bandit (2001-2005)	20	20	
GSF 1200 Bandit (2006)	25	28	Front and rear wheel: 860 190 009
GSF 1250 Bandit (2007-2015)	25	28	Front and rear wheel: 860 190 009
GSX 1200 Inazuma (1999-2000)	20	20	

Suzuki MODEL	AXLE DIAMETER		REMARKS Special adaptors (P/No.)
	front	rear	
GSX 1250 FA (2010-)	25	28	
GSX 1300 R Hayabusa (1999-2007)	25	32	Front and rear wheel: 860 190 009
GSX 1300 R Hayabusa (2008- 2017)	25	28	Front and rear wheel: 860 190 009
GSX 1400 (2005-2007)	28	32	Front and rear wheel: 860 190 009
VS 1400 Intruder (1987-2003)	15	17	
VL 1500 LC Intruder (1998-2017)	17	20	
VZR Intruder M1800R (2006-2017)	25	25	Front and rear wheel: 860 190 009
Intruder C 1500 T (2013-2017)	25	25	
VLR 1800 Intruder C1800 (2008-2012)	25	25	Front and rear wheel: 860 190 009
B-King (2008-2012)	25	28	Front and rear wheel: 860 190 009

Triumph MODEL	AXLE DIAMETER		REMARKS Special adaptors (P/No.)
	front	rear	
TT 600 (2000-2003)	20	20	
Daytona 600 (2003-2004)	20	20	
Daytona 675 / R (2006-)	20	20	
Speed Four (2003-2005)	20	20	
Street Triple / R (675) (2007-)	20	20	
Street Triple (all 2018-) (765ccm)	20	20	
Scrambler 865/899 (2006-)	17	17	
Trident 750 (1992-1998)	25	20	
Daytona Super III (1994-1996)	25	20	
Daytona 900 (1993-1996)	25	20	
Adventurer 900 (1996-2001)	25	20	
Legend 900 TT (1999-2001)	25	20	
Thunderbird 900 (all types) (1995-2004)	20	20	
Trident 900 (1993-1998)	25	20	
Sprint ST 1050 (2005 -2011)	25	Mono-arm	For rear wheel: 1x 860e190 024
Sprint GT 1050 (2011-2015)	25	Mono-arm	For rear wheel: 1x 860e190 022
Sprint RS 955 (2000-2001)	25	20	
Sprint RS 955 (2004)	25	Mono-arm	For rear wheel: 1x 860e190 024
Speed Triple 900/955 (1997-2001)	17	Mono-arm	For rear wheel: 1x 860e190 024
Speed Triple 955 (2002-2004)	20	Mono-arm	For rear wheel: 1x 860e190 024
Speed Triple 1050 (2005-2010)	25	Mono-arm	For rear wheel: 1x 860e190 024
Speed Triple (1050) (2011-)	20	Mono-arm	For rear wheel: 1x 860e190 022
Trophy 900 (1993-2001)	25	20	
Tiger 800 (2011-)	20	20	
Tiger 800 XR (2015-)	20	20	
Tiger 800 XC (2011-)	20	20	
Tiger 900 / 955i (1993-2006)	17	17	
Tiger 1050 Sport / SE (2007-2012)	25	20	

Triumph MODEL	AXLE DIAMETER		REMARKS Special adaptors (P/No.)
	front	rear	
Tiger 1050 Sport (2013)	25	Mono-arm	
Tiger Sport (2014-) 1050ccm	25	Mono-arm	
Tiger Explorer (2012-) 1215ccm	20	Mono-arm	For rear wheel: 1x 860e190 022
Tiger Explorer XC (2013-) 1215ccm			For rear wheel: 1x 860e190 022
Thruxton 865 (2004-2015)	17	17	
Thruxton / Ace (2015)	17	17	
Thruxton/ Thruxton R (2016-)	20	20	
Daytona 955i (1997-2001)	20	Mono-arm	For rear wheel: 1x 860e190 024
Daytona 955i (2002-2006)	20	25	
Bonneville 800 SE (2009-)	17	17	
Bonneville T100 (alle 865/899/ 2005-)	17	17	
Bonneville T120 (2016-)	20	20	
Street Twin (2016-)	20	20	
Street Cup (2017-)	20	20	
Street Scrambler (2019-) 900ccm	20	20	
Street Scrambler XC (2019-) 1200ccm	20	20	
Street Scrambler XE (2019-) 1200ccm	20	20	
Bonneville Speedmaster (2018-)	20	20	
T 595 Daytona 955 (T595/502 955i)	25	Mono-arm	For rear wheel: 1x 860e190 024
Trophy 1200 (1993-2003)	25	20	
Trophy 1200 / SE (2013-2017)	20	Mono-arm	For rear wheel: 1x 860e190 022
Daytona 1200 (1993-1997)	25	20	
America 865 /Speedmaster (2001-)	25	20	
Speedmaster 800/865 (2003-)	25	20	
Thruxton 865 (2004-2015)	17	17	
Thunderbird (all types 2014-)	20	20	
ROCKET 2300 III (all types) (2004-2016)	20	20	

Victory MODEL	AXLE DIAMETER		REMARKS Special adaptors (P/No.)
	front	rear	
Hammer	20	20	
Vision Tour	20	20	
Cross Country	20	20	
Vegas Jackpot	20	20	
Cross Roads	20	20	
Kingpin	20	20	
Vegas	20	20	
Judge	20	20	
Boardwalk	20	20	
Octane	20	20	
High Ball	20	20	
Magnum	20	20	

Victory MODEL	AXLE DIAMETER		REMARKS Special adaptors (P/No.)
	front	rear	
Gunner	20	20	
Jackpot	20	20	

Yamaha MODEL	AXLE DIAMETER		REMARKS Special adaptors (P/No.)
	front	rear	
DT 125 R (1991-2006)	15	20	
XT 125 R (2005-2012)	15	15	
XT 125 X (2005-2011)	15	15	
SR 125 (1989-2002)	15	15	
TDR 125 (1997-2002)	15	17	
TW 125 (1999-2003)	15	17	
XV 125 (1997-2001)	15	15	
YBR 125 (2005-)	15	15	
YZF R 125 (2008-)	15	15	
TZR 125 (1997-1999)	17	15	
TDR 250 (1988-1989)	15	20	
TZR 250 (1987-1990)	15	12	
XV 250 (1989-2000)	15	15	
DT 125 R (1991-2006)	15	20	
XT 125 R (2005-2012)	15	15	
XT 125 X (2005-2011)	15	15	
SR 125 (1989-2002)	15	15	
TDR 125 (1997-2002)	15	17	
TW 125 (1999-2003)	15	17	
XV 125 (1997-2001)	15	15	
YBR 125 (2005-)	15	15	
YZF R 125 (2008-)	15	15	
TZR 125 (1997-1999)	17	15	
TDR 250 (1988-1989)	15	20	
TZR 250 (1987-1990)	15	12	
XV 250 (1989-2000)	15	15	
WR 250 R (2008-2017)	17	22	
WR 250 X (2008-2015)	17	22	
MT-03 (2015-)	15	17	
YZF-R3 (2015-)	15	15	
RD 350 LC (1980-1989)	12	15	
XT 350 (1985-1995)	15	17	
XS 400 (1980-1984)	15	17	
SR 400 (2014-2016)	17	17	
WR 400 F (1998-2002)	20	20	
WR 450 F (2012-)	20	22	
RD 500 (1984-1985)	15	17	

Yamaha MODEL	AXLE DIAMETER		REMARKS Special adaptors (P/No.)
	front	rear	
SR 500 all types	17	17	
XP 500 T max. (2001-2007)	15	17	
XP 500 T max. (2008-2011)	22	17	
T-max 500 (2010-2015)	22	28	
XV 500 (1983-1984)	15	15	
XV 535 (1988-2003)	17	15	
XJ 550 (1981-1984)	15	17	
XZ 550 (1982-1984)	15	17	
FZS 600 Fazer (1998-2003)	17	20	
FZ6 600 Fazer/ S2 (2004-2009)	22	28	
FZR 600 (1989-1993)	15	17	
FZR 600 (1994-1995)	17	20	
FZR 600 R (1994-1995)	17	20	
YZF 600 R Thundercat (1996-2002)	17	20	
YZF-R6 (1999-2016)	22	28	
YZF-R6 (2016-)	25	28	
TT 600 S/R (1993-2004)	17	20	
XJ 600 (1984-1991)	15	17	
XJ 600 S/N (1992-2003)	17	17	
XJ 6 (2009-2016)	17	17	
XJ 6F Diversion (2009-2016)	17	17	
XT 600 (1986-2003)	15	17	
XT 600 Z Tenere (1985-1991)	15	17	
XTZ 660 Tenere (1991-1995)	15	17	
XT 660 Z Tenere (2008-2016)	17	17	
XT 660 R (2005-2016)	17	17	
XT 660 X (2005-2016)	17	17	
SRX 600 (1986-1987)	15	17	
XJ 650 (1980-1985)	15	17	
XS 650 / 650 SE (1977-1983)	17	20	
XVS 650 (1997-2007)	17	15	
SZR 660 (1995-1996)	17	15	
MT-03 (2006-)	22	17	
FZ 750 (1985-1994)	15	17	
FZR 750 R (1987-1988)	15	17	
FZR 750 R (1989-1992)	17	20	
FZX 750 (1987-1989)	15	17	
XJ 750 (1982-1985)	15	17	
XS 750 /750 SE (1977-1982)	17	20	
XTZ 750 (1989-1997)	15	17	
MT-07 (all types ab 2014-)	17	20	
XV 750 (1981-1997)	15	17	
XSR 700 (2016-)	17	20	

Yamaha MODEL	AXLE DIAMETER		REMARKS Special adaptors (P/No.)
	front	rear	
YZF 750 (1993-1998)	22	28	
YZF-R7 (1999-2000)	22	28	
Fazer 8 (2011-)	17	28	
Fazer 8 (2013-)	17	22	
FZ 8 (2011-)	17	28	
FZ 8 (2013-)	17	22	
TDM 850 (1991-2001)	17	17	
TRX 850 (1996-1999)	17	20	
XS 850 (1980-1982)	17	20	
XJ 900 all types (1983-2003)	15	17	
MT-09 (all types 2015-)	17	20	
XSR 900 (2016-)	17	20	
XVS 950 A Midnight Star (2009-)	17	20	
XV 950 (all types 2014-)	17	20	
SCR 950 (2017-)	17	20	
MT-01 (2005-2012)	22	28	
MT-10 (2016-)	25	28	
FZ 1 (2007-)	22	28	
FZ 1 Fazer (2006-)	22	28	
FZR 1000 (1987-1988)	15	17	
FZR 1000 (1989-1993)	17	20	
FZR 1000 (1994-1995)	22	20	
YZF 1000 R Thunderace (1996-2001)	22	28	
YZF R1 (1998-2014)	22	28	
YZF R1 (all types 2015-)	25	28	
FZS 1000 + S (2001-2005)	22	28	
GTS 1000 (1993-1999)	LK100	20	For front wheel: 1x 860e190 006
XV 1000 TR1 (1981-1984)	15	20	
XV 1000 SE (1983-1985)	15	17	
XV 1000 Virago (1986-1988)	15	17	
BT 1100 Bulldog (2002)	17	17	
BT 1100 Bulldog (2003-2006)	22	17	
FJ 1100 (1984-1985)	15	20	
XS 1100 (1980-1983)	17	20	
XV 1100 (1989-1999)	15	17	
XVS 1100 alle (1999-2005)	17	17	
FJ 1200 (1986-1997)	15	20	
XT 1200 Z Super Tenere (2011-)	22	22	
XJR 1200 (1995-1998)	17	20	
XVZ 12 T (1984-1985)	17	20	
V-max (1984-2006)	17	20	
V-max (2009-2016)	22	28	
XP 500 T-max (2001-)	15	17	

Yamaha MODEL	AXLE DIAMETER		REMARKS Special adaptors (P/No.)
	front	rear	
FJR 1300 (2001-2002)	22	20	
FJR 1300 (2002-)	17	22	
FJR 1300 A (2003-)	22	20	
XJR 1300 (1999-2001)	22	20	
XJR 1300 (2003-2017)	22	28	
XVZ 13 T (1989-1992)	17	20	
XVZ 1300 alle (1996-2001)	22	20	
XVS 1300 A (2007-2016)	17	20	
XV 1600 (1999-2004)	22	20	
XV 1900 Midnight Star (2006-)	22	20	
XV 1700 Road Star Warrior (2003-2005)	22	20	

Zero MODEL	AXLE DIAMETER		REMARKS Special adaptors (P/No.)
	front	rear	
DS (2017-)	20	20	
DSR (2017-)	20	20	
S / SR (2017-)	20	20	
SR / F (2017)	20	20	
FX (2017-)	20	20	
FXS (2017-)	20	20	



HAWEKA AG

Kokenhorststrasse 4 ♦ 30938 Burgwedel

☎ +49 5139 8996-0 📠 +49 5139 8996-222

www.haweke.com ♦ Info@haweke.com